

# LED WEATHERPROOF

# LUMINAIRE

**LED Lighting Solutions**

Professional, Innovation, Customization



# ABOUT US

Foshan Hortilite Optoelectronics Co., Ltd. is a joint venture of two public listed lighting manufacturers, FSL (stock code: 000541) and NATIONSTAR (stock code: 002449), a LED innovative lighting solution supplier integrating R&D, manufacturing, sales and customer service.

The purpose to establish this joint company is for a better future growth and development of our lighting business. We are based on the same team of the LED Lighting Division of NATIONSTAR, which has more than 15 years experience in OEM and ODM service for customers in Germany, Italy, Spain, Russia, US, Canada etc., mainly focusing on LED panel, LED batten, LED flexible strips and LED horticulture lighting.

With excellent R&D team and supreme manufacturing standard, we are offering precise and top performance LED products with industry leading technology.

Our goal is not only to meet your requirements, but exceed your expectations.

**FSL**

Founded in 1958, FSL is one of the most competitive lighting brands across China, providing clients with full-range professional lighting solutions. It owns five production bases in Guangdong Province, Henan Province, Jiangsu Province, etc. A complete supply chain system from R&D, manufacturing, sales, services, enabling FSL to produce on a mass scale covering residential lighting, commercial lighting and outdoor lighting.



NATIONSTAR is a national level high-tech enterprise with professional capability in manufacturing LED components (White, RGB and non-visual LED). Founded in 1969, Nationstar ranks the 8th. globally in the list of revenue and market shares for LED packages in 2018 (IHS Markit).



## Background Support

Supported by the mature supply chain system, large-scale production capacity of FSL and leading LED technical advantages of NATIONSTAR.



## Manufacturing Experience

One of the earliest LED lighting products manufacturer in China.

LED flexible strips since 2006, LED panel since 2010, LED batten since 2016, LED horticulture lighting since 2019.

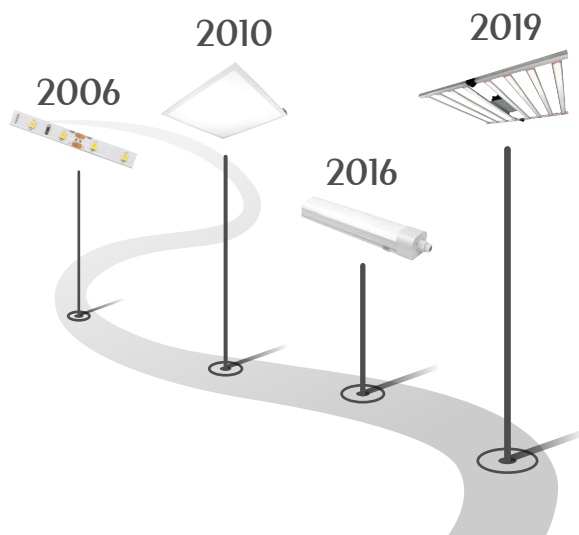



▲ Integrating Sphere

### R & D Strength

More than 30 excellent and professional engineers in electronics, optics, structure, industrial design and other related fields. Professional laboratory (UL&CNAS) are equipped.



▲ Reliability



▲ Lighting Distribution

### Precise and Flexible Manufacturing Mode

Equipped with SMT lines, automatic soldering machines, automatic screw machines, automatic silicone extrusion equipment, automatic aging equipment, etc. to guarantee excellent performance of each product. Offer standard products as well as customized service.



▲ SMT



▲ Assembling



▲ Aging



▲ Packaging

## Batten

Ceiling Mounted



**1**  
IP40  
LED Weatherproof  
Light/JA



**2**  
IP40  
LED Weatherproof  
Light/JO



**3**  
IP20  
LED Batten/T5

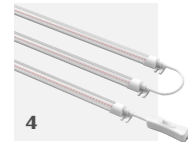

**4**  
IP65  
LED Tube light/B6

## Weatherproof Luminare

Surface Mounted

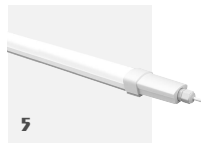

**5**  
IP65  
LED Waterproof  
Fixture/E micro



**6**  
IP65  
LED Waterproof  
Fixture/C-mini



**7**  
IP65  
LED Waterproof  
Fixture IK08/HT



**8**  
IP65  
LED Waterproof  
Fixture IK10/DP

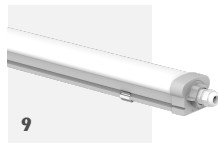

**9**  
IP65  
LED Waterproof  
Fixture IK08/D



**10**  
IP65  
LED Aluminum  
Die-casting Waterproof  
Fixture IK08/HC



**11**  
IP65  
LED EM Intergrated  
Waterproof  
Fixture IK08/HN



**12**  
IP65  
LED Waterproof  
Fixture IK08/TPL-IA



**13**  
IP66  
LED Waterproof  
Fixture IK10/H



**14**  
IP66  
LED Waterproof  
Fixture IK10/HB



**15**  
IP65  
LED Waterproof  
Fixture/F

## Ceiling Light

Ceiling Mounted



**16**  
IP54  
LED Weatherproof  
Light/WPR



**17**  
IP54  
LED Panel/PLS



**18**  
IP54  
LED Bulkhead/  
XDD



**19**  
IP65  
LED freezer light/  
HE





ent in knowledge pays the best interest

6

**Ceiling Mounted**

---

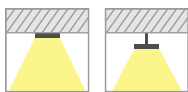

# TPL-JA

## IP40 LED Weatherproof Light

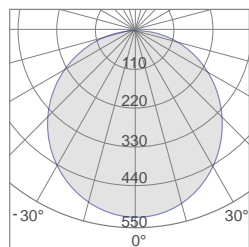
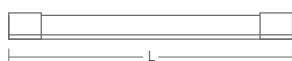

TPL-2JA18 Photometric

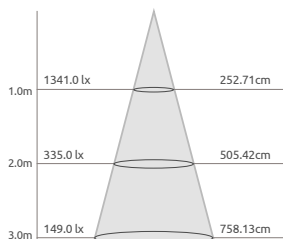

TPL-2JA18 Luminance



AC 220-240V	IP40	Ra 80	120°	IK06	PF> 0.9	5SDCM LED
----------------	------	----------	------	------	------------	--------------

Model No.	Size(mm)	Wattage(W)	Lumen(lm)
TPL-2JA18	L600*W75*H25	18	1530
TPL-4JA36	L1200*W75*H25	36	3060
TPL-5JA45	L1500*W75*H25	45	3825

\*Lumen and Wattage: Type value with ±10% tolerance

Accessories	Product Name	Code	Item
	Surface-mounted Kit	A01613	Snap-fit6504
	Suspension Kit	A01619	Suspension Lines-1000

# TPL-JO

## IP40 LED Weatherproof Light

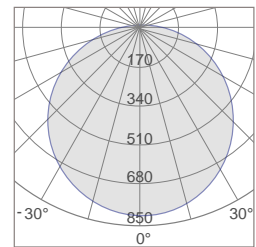
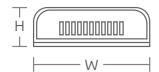
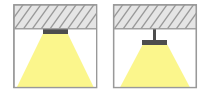

TPL-2J270 Photometric

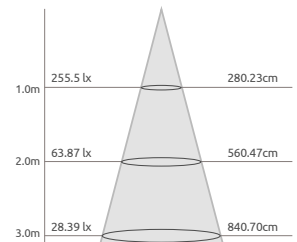

TPL-2J270 Luminance



AC 220-240V	IP40	Ra 80	120°	IK06	PF> 0.9	SSDCM LED
----------------	------	----------	------	------	------------	--------------

Model No.	Size(mm)	Wattage(W)	Lumen(lm)
TPL-2J270	L600*W75*H25	27	2295
TPL-4J540	L1200*W75*H25	54	4590
TPL-5J720	L1500*W75*H25	72	6120

\*Lumen and Wattage: Type value with ±10% tolerance

Accessories	Product Name	Code	Item
	Surface-mounted Kit	A01613	Snap-fit6504
	Suspension Kit	A01619	Suspension Lines-1000



# TPL-T5

## IP20 LED Batten

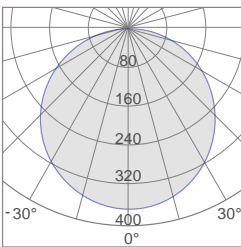
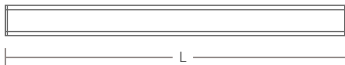

T5-4J16 120° Photometric

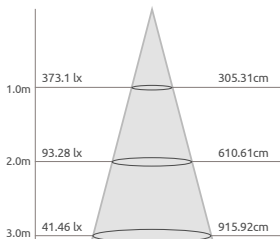

T5-4J16 120° Luminance



AC 220-240V	IP20	Ra 80	120°	IK06	PF> 0.9	5SDCM LED
----------------	------	----------	------	------	------------	--------------

Model No.	Size(mm)	Wattage(W)	Lumen(lm)	Max Multiconnect QTY(PCS)
TPL-T5-1J4	L273*W28*H35	4	400	18
TPL-T5-2J7	L573*W28*H35	7	700	14
TPL-T5-3J10	L873*W28*H35	10	1000	12
TPL-T5-4J16	L1173*W28*H35	16	1600	8

\*Lumen and Wattage: Type value with ±10% tolerance

Accessories	Product Name	Code	Item
	Surface-mounted Kit	A01613	Snap-fit6504



# B6-RB

## IP65 LED Tube light

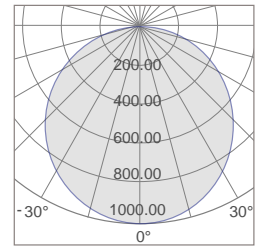
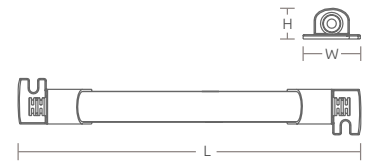

B6-RB Photometric

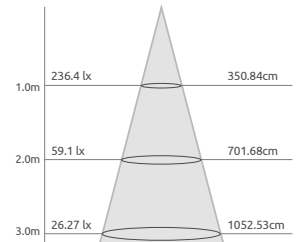

B6-RB Luminance



AC 220-240V	IP65	Ra 80	120°	PF> 0.5	5SDCM LED
----------------	------	----------	------	------------	--------------

Model No.	Size(mm)	Wattage(W)	Lumen(lm)
B6-RB*3	L502*W21*H14	10	1100

\*Lumen and Wattage: Type value with ±10% tolerance

Accessories	Product Name	Code	Item
	Surface-mounted Kit	A01613	Snap-fit6504



**Surface mounted**

---

# TPL-E-micro

## IP65 LED Waterproof Fixture

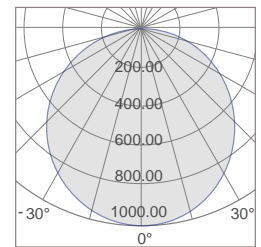
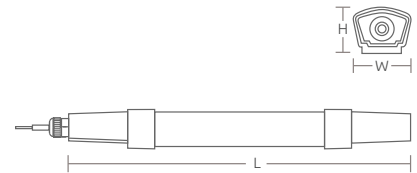
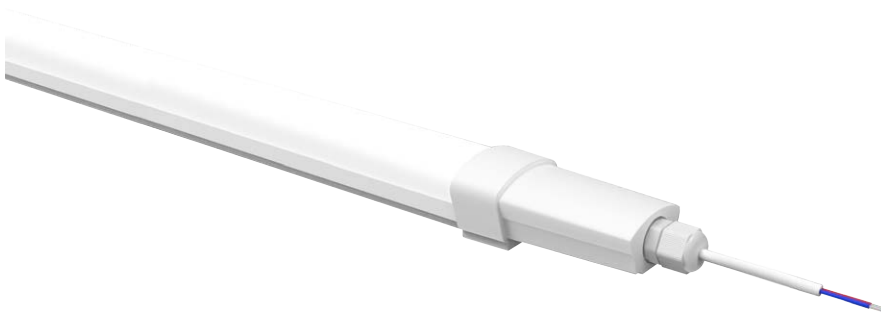
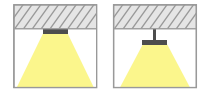

TPL-4E36 Photometric

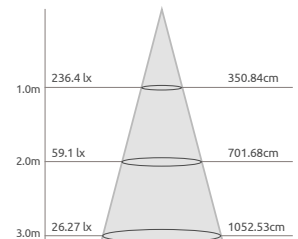

TPL-4E36 Luminance



AC 220-240V	IP65	Ra 80	120°	DALI	IK08	PF> 0.9	SSDCM LED		
----------------	------	----------	------	------	------	------------	--------------	--	--

Model No.	Size(mm)	Wattage(W)	Lumen(lm)
TPL-2E18	L600*W40*H25	18	1800
TPL-4E36	L1200*W40*H25	36	3600
TPL-5E45	L1500*W40*H25	45	4500

\*Lumen and Wattage: Type value with ±10% tolerance

Accessories	Product Name	Code	Item
	Surface-mounted Kit	A01613	Snap-fit6504
	Suspension Kit	A01619	Suspension Lines-1000

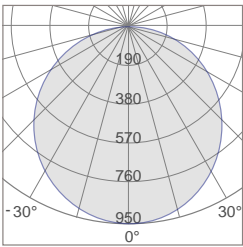
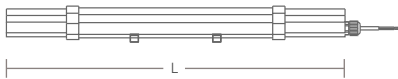
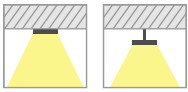

TPL-2C18 Photometric

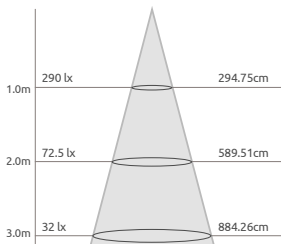

TPL-2C18 Luminance



# TPL-C-mini



## IP65 LED Waterproof Fixture



- AC 220-240V
- IP65
- Ra 80
- 120°
- DALI
- IK08
- PF > 0.9
- 5SDCM LED
- 
- 

Model No.	Size(mm)	Wattage(W)	Lumen(lm)
TPL-2C18	L600*W64*H40	18	1800
TPL-4C36	L1200*W64*H40	36	3600
TPL-5C45	L1500*W64*H40	45	4500

\*Lumen and Wattage: Type value with ±10% tolerance

Accessories	Product Name	Code	Item
	Surface-mounted Kit	A01613	Snap-fit6504
	Suspension Kit	A01619	Suspension Lines-1000



# TPL-HT

## IP65 LED Waterproof Fixture IK08

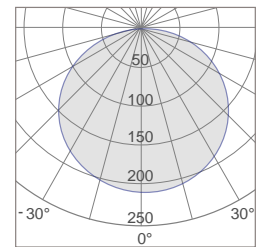
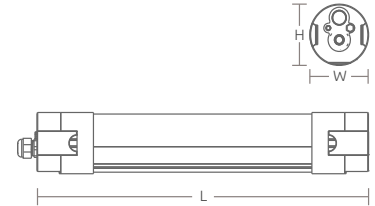
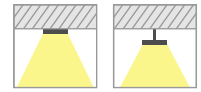

TPL-4HT40 Photometric

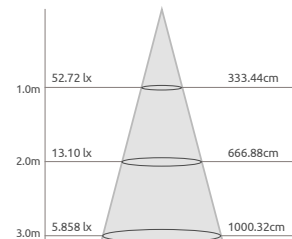

TPL-4HT40 Luminance

3000K 4000K 6500K

- AC 220-240V
- IP65
- Ra 80
- 180°
- DALI
- IK08
- PF > 0.9
- SSDCM LED
- Person icon
- Signal icon

Model No.	Size(mm)	Wattage(W)	Lumen(lm)	Max Multiconnect QTY(PCS)
TPL-2HT20	Φ 79*L600	20	2400	50
TPL-4HT40	Φ 79*L1200	40	4800	25
TPL-5HT60	Φ 79*L1500	60	7200	16

\*Lumen and Wattage: Type value with ±10% tolerance

Accessories	Product Name	Code	Item
	Surface-mounted Kit	A01616	Snap-fit3417
	Suspension Kit	A01619	Suspension Lines-1000

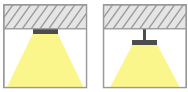

# TPL-DP

## IP65 LED Waterproof Fixture IK10

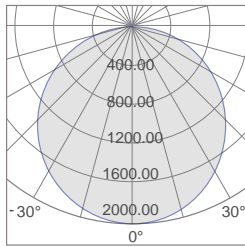
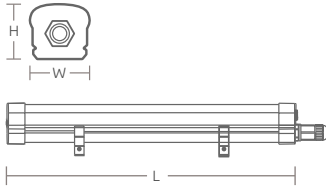

TPL-4D40P Photometric

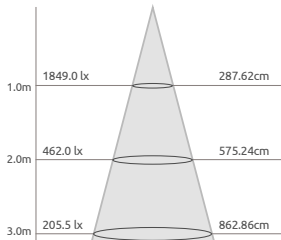

TPL-4D40P Luminance



Weld-free fast connector

- AC  
220-240V
- IP65
- Ra  
80
- 120°
- IK10
- PF>  
0.9
- 5SDCM  
LED
- 
- 

Model No.	Size(mm)	Wattage(W)	Lumen(lm)	Max Multiconnect QTY(PCS)
TPL-2D30P	L600*W70*H60	30	4500	34
TPL-4D40P	L1200*W70*H60	40	6000	25
TPL-5D60P	L1500*W70*H60	60	9000	16

\*Lumen and Wattage: Type value with ±10% tolerance

Accessories	Product Name	Code	Item
	Surface-mounted Kit	A01618	Snap-fit4915
	Suspension Kit	A01619	Suspension Lines-1000

# TPL-D

## IP65 LED Waterproof Fixture IK08

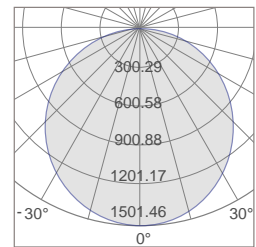
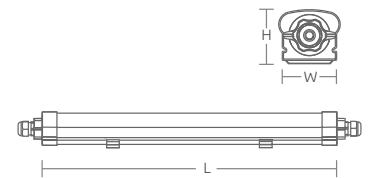
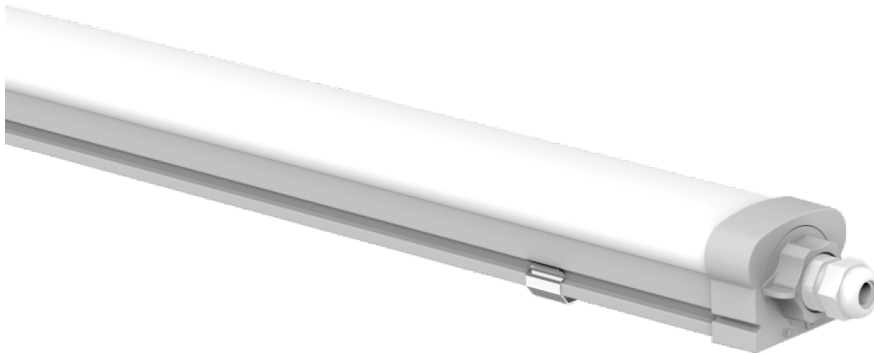
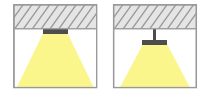

TPL-4D36 Photometric

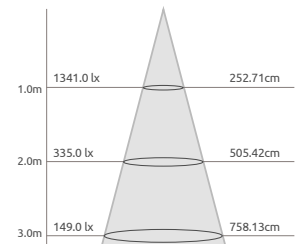

TPL-4D36 Luminance



AC 220-240V	IP65	Ra 80	120°	DALI	IK08	PF> 0.9	5SDCM LED		
----------------	------	----------	------	------	------	------------	--------------	--	--

Model No.	Size(mm)	Wattage(W)	Lumen(lm)	Max Multiconnect QTY(PCS)
HLT-TPL-2D18	L600*W68*H56	18	2250	25
HLT-TPL-4D36	L1200*W68*H56	36	4500	12
HLT-TPL-5D50	L1500*W68*H56	50	6250	9

\*Lumen and Wattage: Type value with ±10% tolerance

Accessories	Product Name	Code	Item
	Surface-mounted Kit	A01618	Snap-fit4915
	Suspension Kit	A01619	Suspension Lines-1000

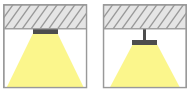

# TPL-HC

IP65 LED Aluminum Die-casting  
Waterproof Fixture IK08

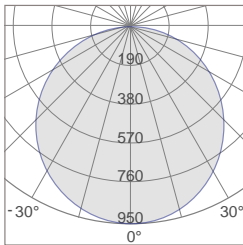
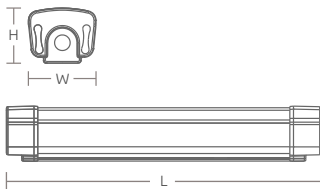

TPL-4HC40 Photometric

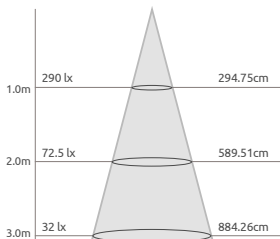

TPL-4HC40 Luminance



- AC 220-240V
- IP65
- Ra 80
- 120°
- DALI
- IK08
- PF > 0.9
- 5SDCM LED
- 
- 

Model No.	Size(mm)	Wattage(W)	Lumen(lm)	Max Multiconnect QTY(PCS)
TPL-2HC20	W89*H42*L600	20	2400	50
TPL-4HC40	W89*H42*L1200	40	4800	25
TPL-5HC60	W89*H42*L1500	60	7200	16

\*Lumen and Wattage: Type value with ±10% tolerance

Accessories	Product Name	Code	Item
	Surface-mounted Kit	A01613	Snap-fit6504
	Suspension Kit	A01619	Suspension Lines-1000



# TPL-HN

IP65 LED EM Intergrated  
Waterproof Fixture IK08

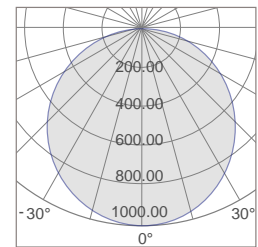
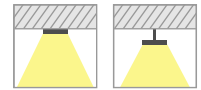

TPL-4HN40 Photometric

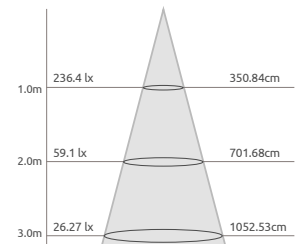

TPL-4HN40 Luminance



- AC 220-240V
- IP65
- Ra 80
- 120°
- DALI
- IK08
- PF > 0.9
- SSDCM LED
- Walking person icon
- Signal icon

Model No.	Size(mm)	Wattage(W)	Lumen(lm)	Max Multiconnect QTY(PCS)
TPL-2HN20	W74*H62*L600	20	2400	50
TPL-4HN40	W74*H62*L1200	40	4800	25
TPL-5HN60	W74*H62*L1500	60	7200	16

\*Lumen and Wattage: Type value with ±10% tolerance

Accessories	Product Name	Code	Item
	Surface-mounted Kit	A01614	Snap-fit4517
	Suspension Kit	A01619	Suspension Lines-1000

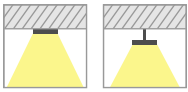

# TPL-IA

## IP65 LED Waterproof Fixture IK08

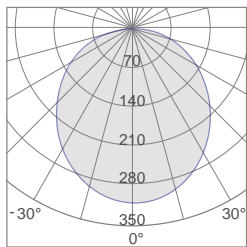
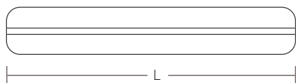

TPL-4IA40 Photometric

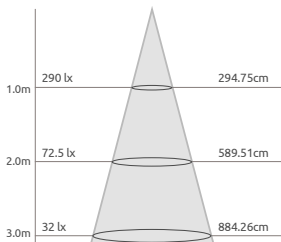

TPL-4IA40 Luminance



AC 220-240V	IP65	Ra 80	120°	DALI	IK08	PF> 0.9	5SDCM LED		
----------------	------	----------	------	------	------	------------	--------------	--	--

Model No.	Size(mm)	Wattage(W)	Lumen(lm)	Max Multiconnect QTY(PCS)
TPL-2IA20	L618*W116*H74	20	2400	50
TPL-4IA40	L1215*W116*H74	40	4800	25
TPL-5IA60	L1515*W116*H74	60	7200	16

\*Lumen and Wattage: Type value with ±10% tolerance

Accessories	Product Name	Code	Item
	Surface-mounted Kit	A01614	Snap-fit4517
	Suspension Kit	A01619	Suspension Lines-1000

# TPL-H

## IP66 LED Waterproof Fixture IK10

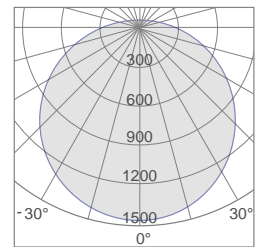
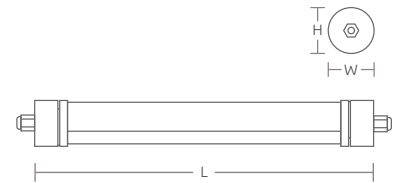
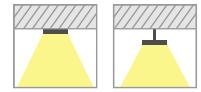

TPL-4H40 Photometric

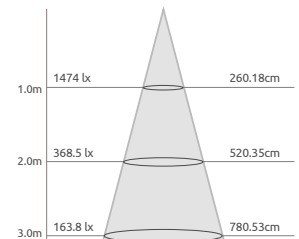

TPL-4H40 Luminance



- AC 220-240V
- IP66
- Ra 80
- 180°
- IK10
- PF > 0.9
- 5SDCM LED
- Person icon
- Signal icon

Model No.	Size(mm)	Wattage(W)	Lumen(lm)	Max Multiconnect QTY(PCS)
TPL-2H20	L600*Φ75	20	3000	50
TPL-4H40	L1200*Φ75	40	6000	25
TPL-5H60	L1500*Φ75	60	9000	16

\*Lumen and Wattage: Type value with ±10% tolerance

Accessories	Product Name	Code	Item
	Surface-mounted Kit	A01614	Snap-fit4517
	Suspension Kit	A01619	Suspension Lines-1000

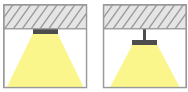

# TPL-HB

## IP66 LED Waterproof Fixture IK10

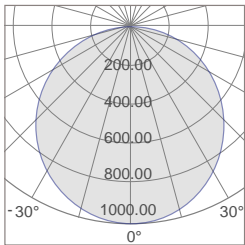
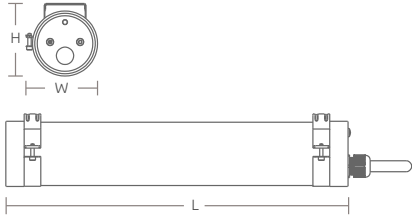

TPL-4HB40 Photometric

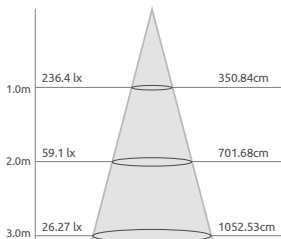

TPL-4HB40 Luminance



Model No.	Size(mm)	Wattage(W)	Lumen(lm)	Max Multiconnect QTY(PCS)
TPL-2HB20	80*86*L600	20	2400	50
TPL-4HB40	80*86*1200	40	4800	25
TPL-5HB60	80*86*1500	60	7200	16

\*Lumen and Wattage: Type value with ±10% tolerance

Accessories	Product Name	Code	Item
	Surface-mounted Kit	A01614	Snap-fit4517
	Suspension Kit	A01619	Suspension Lines-1000



# TPL-F

## IP65 LED Waterproof Fixture

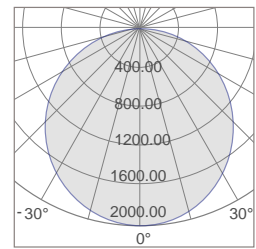
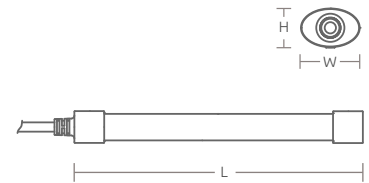

TPL-4F10 Photometric

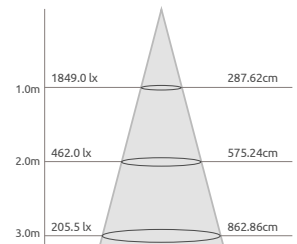

TPL-4F10 Luminance



- AC 220-240V
- IP65
- Ra 80
- 120°
- PF > 0.9
- SSDCM LED
- Icon: Running person
- Icon: Signal waves

Model No.	Size(mm)	Wattage(W)	Lumen(lm)
TPL-4F10	L1200*W26*H16mm	10	1200

\*Lumen and Wattage: Type value with ±10% tolerance

Accessories	Product Name	Code	Item
	Surface-mounted Kit	A01611	Snap-fit1127



**Ceiling Mounted**

---

# WPR-B

## IP54 LED Weatherproof Light

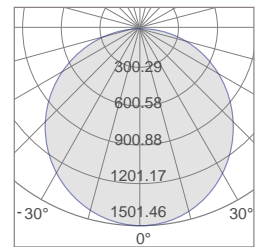
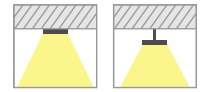

WPR-4B40 Photometric

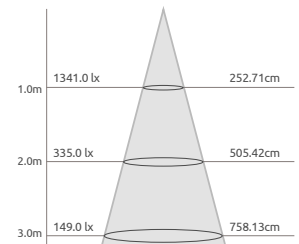

WPR-4B40 Luminance



AC 220-240V	IP54	Ra 80	120°	DALI	PF > 0.9	SSDCM LED	Human icon	Running icon
----------------	------	----------	------	------	-------------	--------------	------------	--------------

Model No.	Size(mm)	Wattage(W)	Lumen(lm)	Max Multiconnect QTY(PCS)
WPR-2B20	W200*H73*L600	20	2400	50
WPR-4B40	W200*H73*L600	40	4800	25
WPR-5B50	W200*H73*L600	50	6000	16

\*Lumen and Wattage: Type value with ±10% tolerance

Accessories	Product Name	Code	Item
	Surface-mounted Kit	A01618	Snap-fit4915
	Suspension Kit	A01619	Suspension Lines-1000



# PLS-J

## IP54 LED Panel

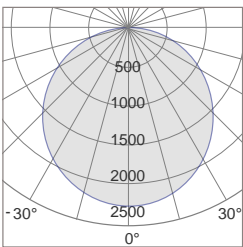
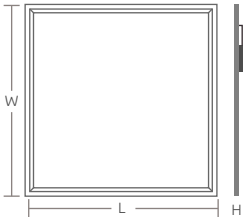

PLS-6060 110° Photometric

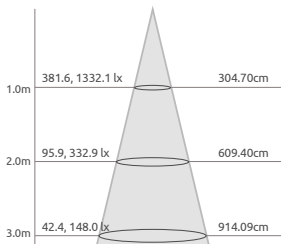

PLS-6060 Luminance



AC 220-240V	IP20 ↓ IP54	Ra 80	110°	DALI	0-10V	CCT	PF> 0.9	SSDCM LED
----------------	-------------------	----------	------	------	-------	-----	------------	--------------

Model No.	Size (mm)	Wattage (W)	Lumen (lm)
HLT-PLS-6060J36	L595*W595*H8.5	36	3960
HLT-PLS-6262J36	L620*W620*H8.5	36	3960

\*Lumen and Wattage: Type value with ±10% tolerance

Accessories	Product Name	Code	Item
	DALI DT8 Flicker Free Driver	A01511	LF-GSD040YG
	Flicker Free Driver	A01501	MH-40C100M12
	Spring Brackets	A01503	Spring Bracket Kit

# XDD-HA15

## IP54 LED Bulkhead

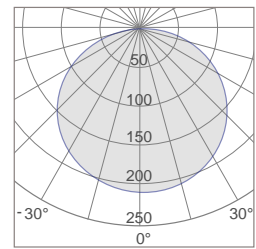
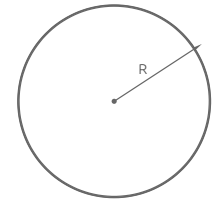

XDD-HA15 Photometric

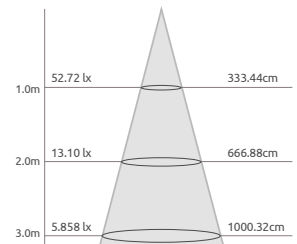

XDD-HA15 Luminance



- AC 220-240V
- IP54
- Ra 80
- 120°
- DALI
- PF > 0.9
- 5SDCM LED
- Icon: Running person
- Icon: Signal waves

Model No.	Size(mm)	Wattage(W)	Lumen(lm)
XDD-HA15	φ300*H73.9	15	1650

\*Lumen and Wattage: Type value with ±10% tolerance

Accessories	Product Name	Code	Item
	Surface-mounted Kit	A01611	Snap-fit1127



# TPL-HE

## IP65 LED freezer light

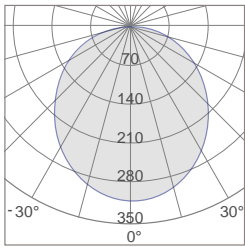
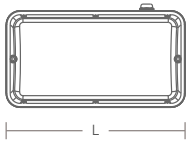
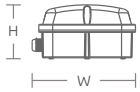

TPL-2HE30 Photometric

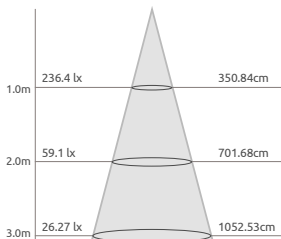

TPL-2HE30 Luminance



- AC  
220-240V
- IP65
- Ra  
80
- 120°
- DALI
- PF>  
0.9
- 5SDCM  
LED
- 
- 

Model No.	Size(mm)	Wattage(W)	Lumen(lm)
TPL-2HE30	W148.1*L273.9*H82.5	30	3000

\*Lumen and Wattage: Type value with ±10% tolerance

Accessories	Product Name	Code	Item
	Surface-mounted Kit	A01611	Snap-fit1127

# Optional Solutions

## Sensor On/Off solution

The motion detector can turn on the light based on movement. With this detector built in, light is automatically on when needed and off when not needed.

Rated Load(Max)	400W
Sensitivity	50% / 100%
Delay Time	5s / 90s / 5mins / 15mins
Daylight Sensor	30lux, disable
Microwave Frequency	5.8 GHz +/- 75MHz
Detection Range	Max (diameterx height): 10 x 6m

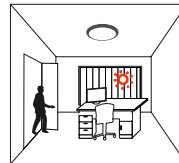

The light keeps off during daytime even when movement is detected (Ambient lux level is above preset daylight threshold)



With movement and insufficient ambient lux level, the light is triggered on by the detector.

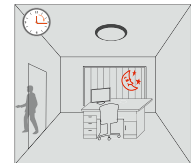

If there is no more movement, the light turns off automatically after preset hold-time.

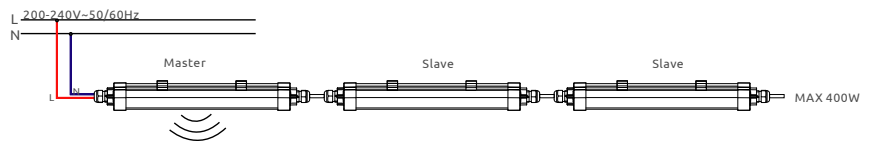
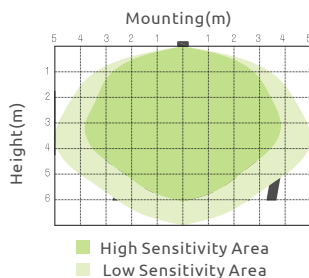

## Sensor dimming solution

Setting the detected distance, ambient lux level for operation, standby time and standby brightness by infrared(IR) remote controller.

Daylight Sensor	OFF/50 LUX/200 LUX/300 LUX
Delay Time	0/30S/10mins/30mins
Standby Time	0/30S/10mins/30mins
Standby Brightness	25%/50%/75%/100%
Detection Range	Max (diameterx height): 10x10m
Microwave Frequency	5.8 GHz +/- 75MHz

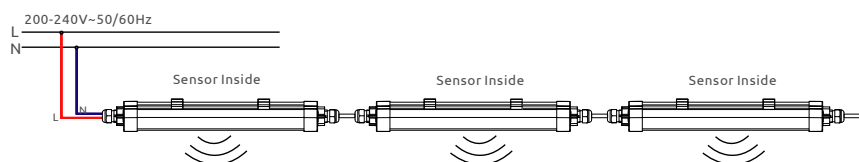
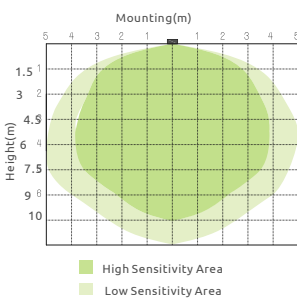
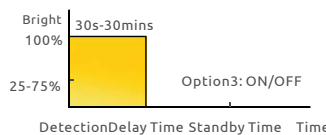
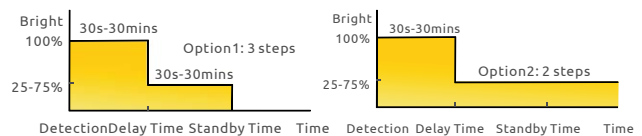



# Optional Solutions

## Emergency Solution

- NiMH batteries;
- Replaceable battery modules improve product life;
- Green charge status display LED;
- Maintain 10% power in emergency condition;
- 90 minutes for emergency

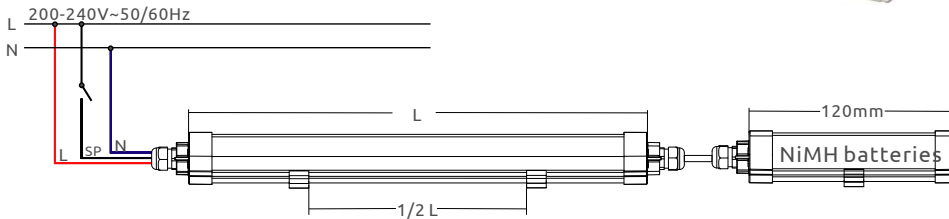

## DALI Solution

- Dimming range 10-100%;
- One4all(DALI-2 DT6)DSI,switchDIM,corridorFUNCTION V2);
- Stand-by<0.4W;
- Use Tridonic DALI2 driver.



L	SP	LED
ON	ON	100%
ON	OFF	OFF
OFF	ON	10%
OFF	OFF	OFF

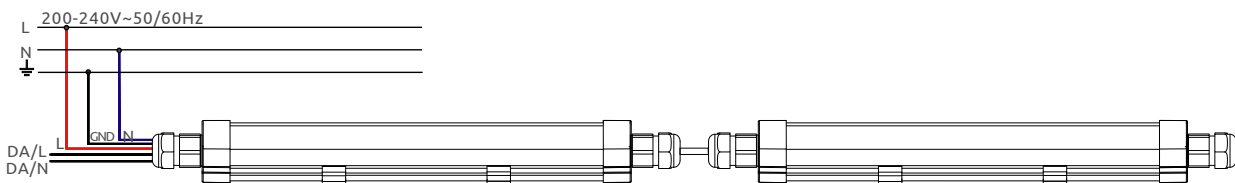

# Industrial Lighting

## Fast Connector



### TECHNICAL PARAMETERS

Connectors	Number of poles	Color	Material-Metal	Material-Resin	Material-Seal	Rated voltage	Rated current
M12	2	black/white	Phosphor bronze	PA66	Silicone	250V	16A
M20	3	black/white	Phosphor bronze	PA66	Silicone	250V	16A
M27	5	black/white	Phosphor bronze	PA66	Silicone	250V	16A

Rated impulse voltage	Protection grade	Wire diameter	Wire tupe	Cable diameter	Stripping length	Dimensions	Be applied to
2500V	IP68	0.75-1.5MM2 (AWG18-15)	multi-strand wire Single conductor	5-7mm	10-12mm	MAX38.0	TPL-C Series
2500V	IP68	0.75-1.5MM2 (AWG18-15)	multi-strand wire Single conductor	4-7mm/7-11mm	10-12mm	MAX55.0	TPL-A Series TPL-D Series
2500V	IP68	0.75-1.5MM2 (AWG18-15)	multi-strand wire Single conductor	10-14mm	10-12mm	MAX60.0	TPL-A-DALI TPL-D-DALI

### Installation Instruction

#### Surface Mounting

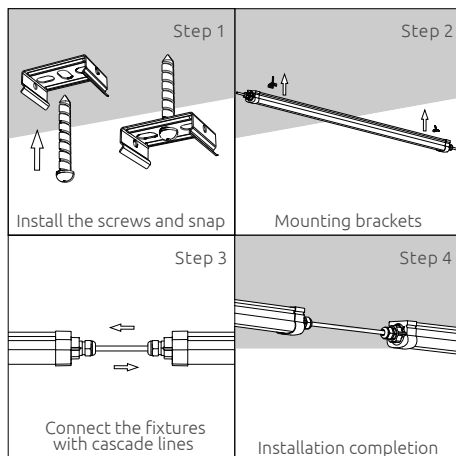

#### Suspending Mounting

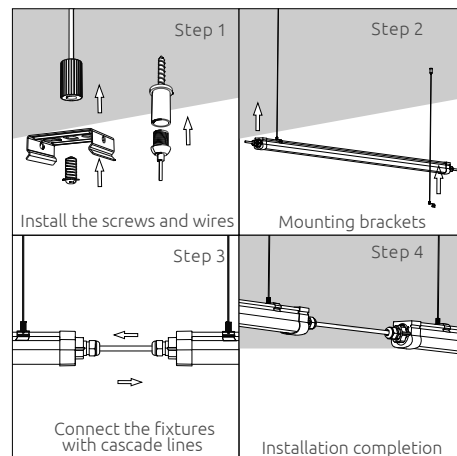







**Foshan Hortilite Optoelectronics Co.,Ltd.**

 TEL  
+ 86-757-8228-2975

 MAIL  
sales@hortilite.com

 WEB  
www.hortilite.com

 ADD  
19 Hengchang Road, Fuwan Industrial Park, Hecheng Street  
Foshan, Guangdong, China